



Type 15 Series Electrode Stabilization Ovens



PART #	DESCRIPTION (All 50-60 Cycles)	TEMP RANGE**	INSULATION	CHAMBER SIZE	CAPACITY	WEIGHT & DIMENSIONS				
Portable Model: Type 15 Series Ovens with North American Power Cord CE cUL US										
1205532	120/240V AC* @ 600 watts	100° to 300°F (38° to 149°C) +/-25°F (14°C) Adjustable Thermostat	1½" fiberglass	14" diameter x 19¾" deep	150 lb (70 kg) of 18" electrodes	80 lb 19¾" x 21¾" x 28"				
1205530	120/240V AC* @ 600 watts with digital thermometer installed									
Bench Model: Type 15 Series Ovens with North American Power Cord CE cUL US										
1205533	120/240V AC* @ 600 watts									
1205531	120/240V AC* @ 600 watts with digital thermometer installed					64 lb 22¼" x 17½" x 20½"				
Portable Model: Type 15 Series Ovens with European/Schuko Power Cord CE cUL US										
1215532	120/240V AC* @ 600 watts									
1215530	120/240V AC* @ 600 watts with digital thermometer installed					80 lb 19¾" x 21¾" x 28"				
Bench Model: Type 15 Series Ovens with European/Schuko Power Cord CE cUL US										
1215533	120/240V AC* @ 600 watts									
1215531	120/240V AC* @ 600 watts with digital thermometer installed					64 lb 22¼" x 17½" x 20½"				
Portable Model: Type 15 Series Ovens with U.K. Power Cord CE cUL US										
1225532	120/240V AC* @ 600 watts									
1225530	120/240V AC* @ 600 watts with digital thermometer installed	80 lb 19¾" x 21¾" x 28"								
Bench Model: Type 15 Series Ovens with U.K. Power Cord CE cUL US										
1225533	120/240V AC* @ 600 watts									
1225531	120/240V AC* @ 600 watts with digital thermometer installed	64 lb 22¼" x 17½" x 20½"								

*Operation on Direct Current (DC) will damage oven and void warranty.
**Average stabilized temperature @ 70°F ambient temperature.

OVEN DESCRIPTION

PRIOR TO USE

1. Check for correct power supply cord and plug. Confirm that the voltage selector switch setting corresponds with the power supply to be used. Unit is set to 240V when shipped.
2. Verify the oven is empty before heating.
3. Check nameplate for voltage ratings.
4. Check for desired thermometer (if equipped) display units (°F or °C). Unit is set to °F when shipped. To change to °C, see *Temperature Indication* section in this manual.

POWER SUPPLY

DryRod II ovens are designed to run on AC voltage and accept either 120 or 240 volts +/-10%. When power is supplied, the indicator light will illuminate.

DryRod II ovens are supplied with a voltage selector switch to operate on either 120 or 240 AC voltage. Please be sure to set the switch to the proper voltage being used. Operation outside these voltages will impact oven temperature.

AMP DRAW

120V = 5.0 amps 240V = 2.6 amps

POWER CORDS

DryRod II ovens are supplied with a female IEC 320 locking power inlet. This inlet accepts a male IEC 320 locking power cord to provide a fixed connection. The secured cord can be removed for replacement by applying pressure to the yellow tab on top of the locking power cord.



LOCKING POWER INLET & CORD

DryRod II oven power cords are rated for 100-240 volts. When connected to a properly grounded receptacle, these ovens meet the nationally recognized standards for which they are marked.

DryRod II ovens are available with a three blade North American power cord for 120 volt AC operation. The ovens are also available with a European/Schuko plug configuration for operation on 240 volt AC. (See *Replacement Parts* section in this manual for optional power cords. See front page for standard oven configuration with power cord options.)

ELECTRODE STORAGE

Type 15 Series ovens will fit two full 50lb cans of electrodes with additional secondary storage.

DryRod II ovens are not airtight and electrodes stored within will start absorbing ambient moisture as soon as the oven cools. We recommend removal of electrodes at shift end and storage in suitable larger holding ovens until re-issued.

Phoenix International, Inc.

DryRod II ovens are not to be used for re-baking or re-conditioning contaminated electrodes. They are designed to accept electrodes in 100% usable condition and to maintain that condition until consumed at the job site. For optimum stabilization, oven should be hot when loaded and kept powered for as long as electrodes are being stored.

GUIDE TO STORAGE

Electrodes should be stored according to electrode supplier recommendations. In the absence of detailed storage information from your electrode manufacturer, the *Guide To Electrode and Flux Stabilization* section in this manual may be used as an indication of approximate temperatures.

A laminated version and poster size version of the Guide To Electrode and Flux Stabilization is available by contacting Phoenix International, Inc.

REPAIR: SPARE PARTS

These instructions contain wiring diagrams and a repair parts list for your DryRod II oven. For critical welding operations requiring continuous holding, we would suggest carrying all the parts listed in the *Suggested Spare Parts* section in this manual.

Spare parts are available at www.phx-international.com or by contacting your local distributor.

TEMPERATURE SETTINGS

DryRod II ovens utilize a variable thermostat, providing an operating range of 100°-300°F (38°-149°C) average stabilized load temperatures.

The oven operating temperature is set by rotating the thermostat knob clockwise to increase the temperature of the unit. To decrease the temperature rotate the knob counter-clockwise. This setting is approximate and may need slight adjustment once the oven temperature stabilizes.

TEMPERATURE INDICATION

DryRod II ovens (Part #1205530 and #1205531) are supplied with an optional battery powered digital thermometer to indicate the actual temperature inside oven in either °F or °C.

The thermometers are supplied in °F mode. Conversion to °C mode is accomplished by pressing the button located in the battery holder. This will cycle between °F and °C. Thermometers are powered by one AA battery.

Replacement of the battery is also covered in the troubleshooting section of this manual.

WHEELS & RETRACTING HANDLE

Specific models of the DryRod II ovens (Part #1205532 and #1205530) are supplied with wheels and a retracting handle for easy portability.

The wheels are supplied with a steel hub and ball bearings to withstand wear over years of service. The handle is supplied with a pin and clip to lock the handle in either the extended or retracted positions. The retracted position is typically used for shipping and/or storage of the oven.

OVEN FAILS TO OPERATE - NO HEAT

1. If the indicator light does not illuminate, check power supply.
2. Confirm cord is plugged fully into power inlet. Check complete power cord for continuity. If defective, replace the entire cord.
3. Check indicator light. Using a volt meter, confirm voltage to the light leads. If voltage is confirmed and light does not illuminate, replace light. *Please note the indicator light is neon and cannot be checked for continuity.*
4. Disconnect heating element from the thermostat (under shell top/lid assembly). Check heating element for continuity. If no continuity, replace heating element.
5. Disconnect wiring from the thermostat. Turn the thermostat knob to the lowest temperature setting (counter-clockwise). Check for continuity through thermostat. If no continuity, replace thermostat.

OVEN OPERATES: LOW HEAT, DOES NOT HEAT TO DESIRED TEMPERATURE

1. Check power supply to confirm voltage is within acceptable range of 120 or 240 volts AC +/-10%.
2. Check that the voltage selector switch setting corresponds with the power supply to be used.
3. Check that the variable thermostat is properly set to the desired temperature.
4. Check that enough time has been allowed for heat-up. A cold, fully loaded oven may take up to four hours to fully heat and stabilize.
5. Check that the variable thermostat is securely mounted. A loosely mounted thermostat will not properly sense the oven temperature.



CAUTION:

To provide continued protection against risk of electrical shock, power cord must be connected to a properly grounded outlet.

To avoid damage, never place oven in contact with welding current.

Store in dry location. Unit not to be exposed to rain or moisture.

Do not use handles to lift loaded oven. Serious injury may result.

THERMOMETER INDICATES IN WRONG UNITS: °F OR °C (IF EQUIPPED)

1. Disconnect power from the unit.
2. Remove the bottom cover from the base to expose thermometer battery housing.
3. Changing to either °F or °C is accomplished by pressing the button located in the battery holder.
4. Re-install the battery and bottom cover prior to putting the oven back in service.

THERMOMETER INOPERABLE (IF EQUIPPED): REPLACE BATTERY

Indicated by a weak or absent display.

1. Disconnect power from the unit.
2. Remove the bottom cover from the base.
3. Remove the battery from the holder and replace with a fresh AA 1.5V battery. (Alkaline batteries are recommended.) Check that display is operational. If not, replace thermometer (Part #1257420). (See *Replacement Parts* section in this manual.)
4. Re-install the battery and bottom cover prior to putting the oven back in service.



CAUTION:

Disconnect power before opening or servicing unit. Make sure oven is cooled before opening or servicing unit.

Hot Surfaces! Use extreme care to avoid possible burns or personal injury. Protective gloves and personal protective equipment are recommended.

SUGGESTED SPARE PARTS

For normal daily operation, the following spare parts and quantities are recommended to have inventoried for every 10 units of DryRod II Ovens in use.

SUGGESTED SPARE PART	QUANTITY PER 10 OVENS	PART #
Heating Element Kit	1	1257370
Variable Thermostat Kit	1	1257430
Locking Power Connection Kit	1	1257395
Indicator Light	1	1257400
Voltage Selector Kit	1	1257410



NOTE:

For users of large oven quantities, or users not in North America, we recommend keeping an inventory of additional spare parts to support day to day operation.

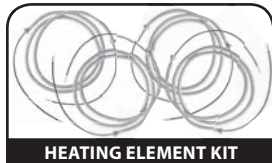

WIRING DIAGRAM



NOTE:

Jumper wires must be installed outside of insulation.

Thermometer probe wire (not shown) must be installed outside of insulation.



CAUTION:

All wiring should be done by licensed electricians in accordance with state and local codes, as well as the NEC (National Electrical Code) Standards. Improper installation or use may result in serious injury. Always remove oven from power source before troubleshooting or repairing.

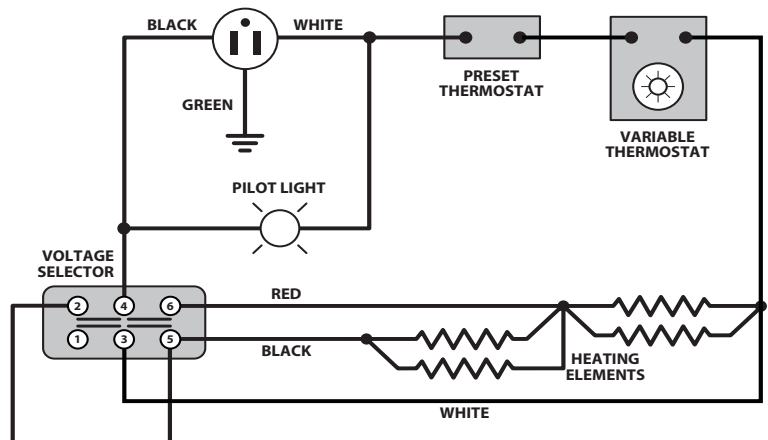

ADDITIONAL PRODUCTS AVAILABLE



Type 300 Series
Stationary Electrode Oven



Type 5 Series
Portable Electrode Oven



Safetube® Industrial
Storage Container

Phoenix International, Inc.

8711 West Port Avenue • Milwaukee, WI 53224 USA • Telephone: 414-973-3400 • Fax: 414-973-3275

www.phx-international.com



ORDERING INFORMATION

To order spare or replacement parts, please visit our website: www.phx-international.com.
When ordering, please confirm that you are ordering parts for the correct oven.

#	DESCRIPTION	QTY	PART #	PORTABLE MODEL	BENCH MODEL
	Insulation	1	1257320	Yes	Yes
9	Heating Element Kit	1	1257370	Yes	Yes
16	Lid Assembly Kit (Portable Model)				
	Lid Assembly	1	1257250	Yes	No
	Insulation	1			
8	Lid Assembly Kit (Bench Model)				
	Lid Assembly	1	1257251	No	Yes
	Insulation	1			
13	Latch Kit				
	Latch	1	1257380	Yes	Yes
	Rivet	2			
10	Variable Thermostat Kit				
	Variable Thermostat	1	1257430	Yes	Yes
	Nut	1			
	Knob	1			
5	Preset Thermostat Kit				
	Preset Thermostat	1	1257435	Yes	Yes
	Rivet	2			
14	Voltage Selector Switch Kit				
	Rivets	2	1257410	Yes	Yes
	120/240V Selector Switch	1			
15	Indicator Light	1	1257400	Yes	Yes
1	Thermometer Kit				
	Digital Thermometer	1	1257420	Yes	Yes
	Screw	2			
	Label	1			
	Clamp	1			
	Jumper Wire Kit				
	Power Wires	8	1257533	Yes	Yes
	Ground Wire	1			
3	North American Power Cord	1	1257540	Yes	Yes
2	European Schuko Power Cord	1	4131046	Yes	Yes
3	Power Inlet Kit				
	Rivet	2	1257390	Yes	Yes
	Locking Power Inlet	1			
3	North American Locking Power Connection Kit				
	Rivet	2	1257395	Yes	Yes
	Locking Power Inlet	1			
	120V North American Locking Cord	1			

#	DESCRIPTION	QTY	PART #	PORTABLE MODEL	BENCH MODEL
17	Wheel Kit (Purchase two kits to replace both wheels.)				
	Axle Cap	1	1257445	Yes	No
	Wheel	1			
12	Base Cover Kit (Portable Model)				
	Cover	1	1257200	Yes	No
	Axle	1			
	Pin	1			
	Bracket	1			
	Stiffner	1			
	Nut	4			
	Bolt	4			
	Base Cover Without Wheels (Optional)	1	1257210	Yes	No
6	Pull Handle Kit (Portable Model)				
	T-Handle	1	1257500	Yes	No
	Plug	1			
7	Lower Handle	1	1257501	Yes	No
4	Pin and Clip	1	1257431	Yes	No
11	Base Cover Kit (Bench Model)				
	Base Cover	1	1257201	No	Yes
	Screws	12			



1 Thermometer Kit



3 North American Locking Power Connection Kit



2 European/Schuko Power Cord

REPLACEMENT PARTS

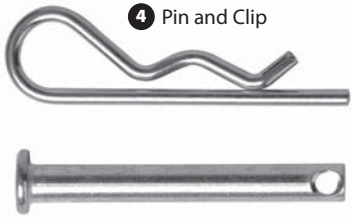

4 Pin and Clip



5 Preset Thermostat Kit



6 Pull Handle Kit

7 Lower Handle



8 Lid Assembly Kit
(Bench Model)

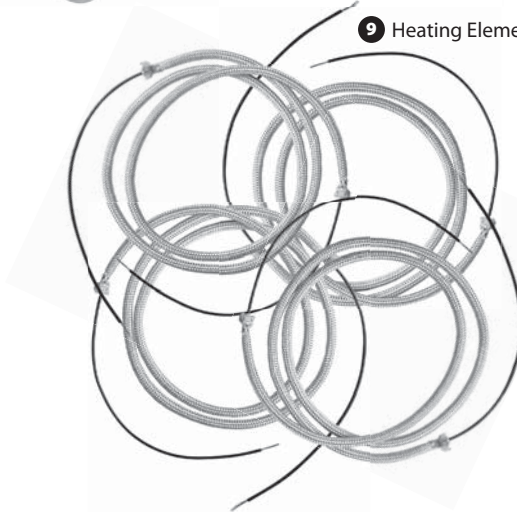

9 Heating Element Kit



10 Variable Thermostat Kit

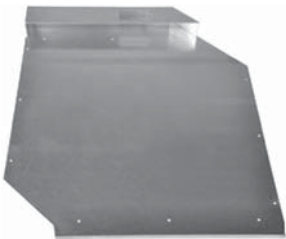

11 Base Cover Kit
(Bench Model)

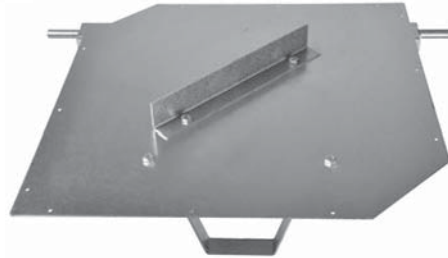

12 Base Cover Kit
(Portable Model)

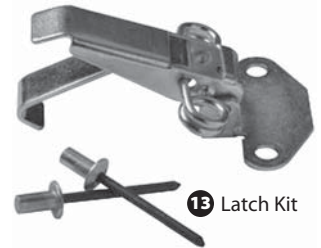

13 Latch Kit

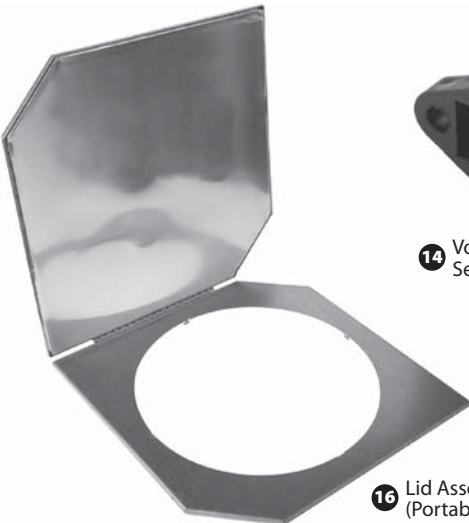

16 Lid Assembly Kit
(Portable Model)



14 Voltage
Selector Switch Kit



15 Indicator
Light



17 Wheel Kit

GUIDE TO ELECTRODE & FLUX STABILIZATION

Eliminate expensive rework and protect welding profits!

- Recondition/rebake procedures for electrode coatings exposed to moisture are included.
- Remove electrodes from cardboard containers before placing in ovens.
- Electrode coatings should not be exposed to the re-baking temperature without first being reconditioned at a lower temperature. Failure to do so may result in breakdown of electrode coatings. After re-baking, lower temperature to holding level until reissued.

AWS (TYPE)	Air Conditioned Storage Before Opening (RH=Relative Humidity)	DryRod Oven Holding Temp After Opening	After Exposure to Moisture, Sufficient Amount of Time to Affect Weld Quality	
			Recondition Step #1	Rebake Step #2
Cellulose EXX10, EX11, EXX20	70°–120°F (21°–49°C) 50% Max RH	100°–120°F (38°–49°C)	Not Recommended	Not Recommended
Titania EXX12, EX13, EXX14	70°–120°F (21°–49°C) 50% Max RH	100°–120°F (38°–49°C)	180°–230°F (82°–110°C) ½ Hour	250°–300°F (121°–149°C) 1 Hour
Iron Powder M.S. EXX24, EX27	70°–120°F (21°–49°C) 50% Max RH	100°–120°F (38°–49°C)	180°–230°F (82°–110°C) ½ Hour	400°–500°F (204°–260°C) ½ Hour
Iron Powder Low Hydrogen EXX18, EX28 Low Hydrogen EXX15, EX16 Low Hydrogen High Tensile EXXX15, EXX16, EXXX18	70°–120°F (21°–49°C) 50% Max RH	250°–300°F (121°–149°C)	180°–220°F (82°–104°C) 1½ Hour	650°–750°F (343°–399°C) 1 Hour
Stainless EXXX-15, EXXX-16	40°–120°F (4.5°–49°C) 60% (+/-10) Max RH	250°–300°F (121°–149°C)	180°–220°F (82°–104°C) 1½ Hour	500°–600°F (260°–316°C) 1 Hour
Inconel Monel Kickel Hard-Surfacing	40°–120°F (4.5°–49°C) 60% (+/-10) Max RH	150°–200°F (66°–93°C)	180°–230°F (82°–110°C) ½ Hour	Not Recommended
Brasses Bronzes	40°–120°F (4.5°–49°C) 60% (+/-10) Max RH	150°–200°F (66°–93°C)	Not Recommended	Not Recommended
Granulated Flux Agglomerated Flux	40°–120°F (4.5°–49°C) 60% (+/-10) Max RH	100°–200°F (38°–93°C)	Contact Manufacturer for Specific Temperatures	
Flux Cored Wire EXXT-1, EXXT-2, EXXT-5, EXXT-G	40°–120°F (4.5°–49°C) 60% (+/-10) Max RH	250°–300°F (121°–149°C)	Contact Manufacturer for Specific Temperatures	

NOTE: Proper redrying temperatures depend upon the electrode type and its condition. Contact your electrode manufacturer for specific instructions involving critical operations. Phoenix International, Inc. does not accept liability for damage to electrodes and/or welded products resulting from the use of this table. Temperatures and times shown are recommended and are not guaranteed to be correct.

The Guide to Electrode & Flux Stabilization

is also available as a laminated card and poster.

Please visit www.phx-international.com or email info@phx-international.com to receive yours **FREE!**

WARRANTY

Phoenix International, Inc. warrants its products against defects in material and workmanship. The company will, at its discretion, repair or replace any properly installed Phoenix International manufactured product which fails under normal operating conditions within one year from date of receipt. Contact the factory for return authorization before returning the product to Phoenix International freight prepaid. If our inspection confirms that the product is defective under terms of this warranty, it will be repaired/replaced and returned freight prepaid.

This warranty applies only to products sold by Phoenix International, Inc. and specifically excludes installation or de-installation labor, transportation or equipment of another manufacturer used in conjunction with Phoenix International products. No other warranty, expressed or implied, exists beyond this warranty declaration.

Phoenix constantly strives to improve its products and therefore reserves the right to change design, materials and specifications without notice.



Take your treated electrodes with you!

Safetube® Industrial Storage Container

- Short-term portable storage of electrodes.
- Pressure fitted O-ring maintains watertight seal and protection from dirt, dust, grease, moisture and more!
- Requires only one quarter turn for a positive threaded seal.
- Optional strap available for easy carrying in the field.
- Unlimited Uses - Protect electrodes, tools, manuals, electronics and more!

For more information on these and other great products from

PHOENIX INTERNATIONAL, INC.

please visit our website at: www.phx-international.com

